

QUASAR

H O L L A N D

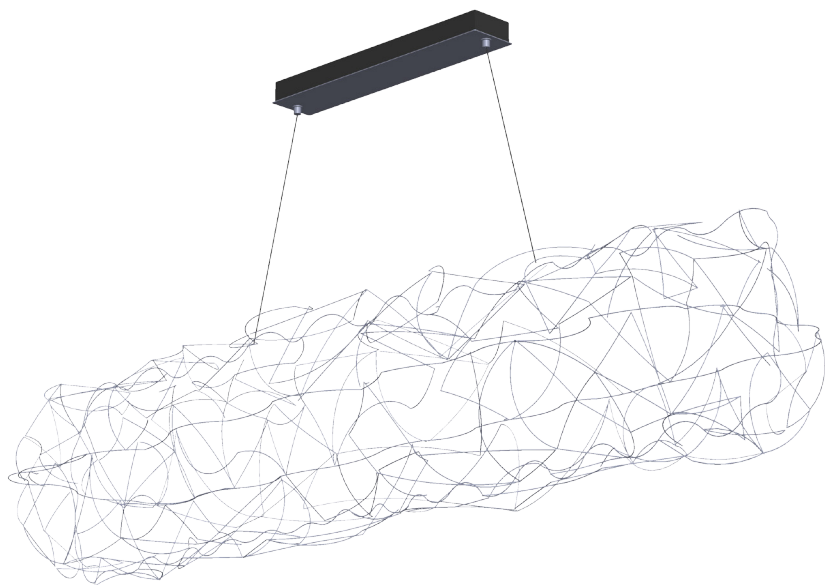

Sirio / Tess

NL Installatie handleiding

DE Installationsanleitung

EN Installation manual

1 NL Informatie / DE Information/ EN Information



Veiligheidsinformatie

- Onderbreek altijd de stroomtoevoer door verwijderen van de toestelzijdige stop bij de montage, onderhoudswerk en het verwisselen van de gloeilampen.
- Een brandende lamp is heet. Let op brandgevaar.
- De lamp mag niet op geleidend materiaal worden gemonteerd.
- Draag geen sieraden bij onderhoudswerkzaamheden.
- Geen (decoratie) materialen aan het armatuur bevestigen.

Technische informatie



- Ingangsspanning 120V of 240V
- Uitgangsspanning 12V
- Beschermingsklasse I
- Beschermingsgraad IP20
- De lamp mag niet in openlucht gebruikt worden
- LED: 12V, 0.6W, 2700K, CRI >90
- Ten minste een afstand van 0,5m tenopzichte van het bestraalde oppervlakte houden.
- Technische gelijkvormigheid volgens EN-Richtlijnen

Sicherheitshinweise

- Bei Montage, Wartungsarbeiten und Leuchtmittelwechsel immer Stromzufuhr durch Entfernen der bauseitigen Sicherung unterbrechen.
- Wenn die Leuchte in Betrieb ist, besteht beim Glühmittel Verbrennungsgefahr!
- Leuchte darf nicht auf leitende Materialien montiert werden.
- Keine Juwelen während Wartung tragen.
- Keine (dekorative) Materialien an die Leuchte befestigen.

Technische Hinweise

- Eingangsspannung 120V oder 240V
- Ausgangsspannung 12V
- Schutzklasse I
- Schutzart IP20
- Leuchte darf nicht im Freien verwendet werden.
- LED: 12V, 0.6W, 2700K, CRI >90
- Mindestabstand zur angestrahlten Fläche 0,5m
- Technische Konformität gemäss EU-Richtlinien

Pflegehinweise

- Leuchten nur mit handelsüblichen, nicht aggressiven und scheuernden Reinigungsmitteln reinigen.
- Gebrauch eine Federbesen

Safety information

- During installation, maintenance work and change of illuminants always interrupt the power supply by removing the respective circuit breaker.
- When switched on, the lamp may cause burns when touched.
- Lamp may not be mounted on conductive materials.
- Don't wear jewelry during maintenance.
- Don't use decoration materials in the lamp.

Technical data

- Input voltage 120V or 240V
- Output voltage 12V
- Safety class I
- Degree of protection IP20
- Lamp must not be used in the open.
- LED: 12V, 0.6W, 2700K, CRI >90
- Minimum distance from illuminated surface 0.5m
- Technical conformity according to European EN-Regulations

Maintenance information

- Lights should only be cleaned using commercially available, non-aggressive, non-scouring cleaning agents.
- Use a feather duster

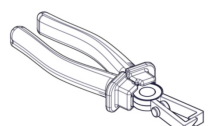
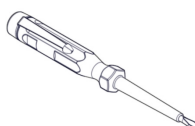
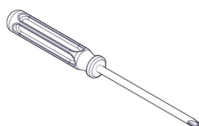
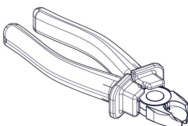
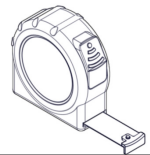
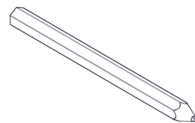
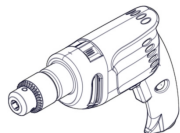
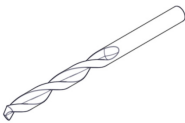

2 NL Optioneel dimmer instructies

Dimmen

Indien besteld met optionele dimmer dan is deze klaar voor gebruik.

Met de afstandsbediening kunt u de lamp aan en uit schakelen.

Het dimmen gaat traploos van 0% tot 100%.

Synchroniseren afstandsbediening en dimmodule

1. Zorg er altijd voor dat de stroom bij installatie van de dimmer uit staat!
2. Sluit de dimmodule aan volgens installatieschema.
3. Na het bedraden de stroom inschakelen. Druk op de inleerknop op de dimmodule, druk direct op een van de knoppen van de afstandsbediening, de lamp knippert nu twee keer en is gebruiksklaar.

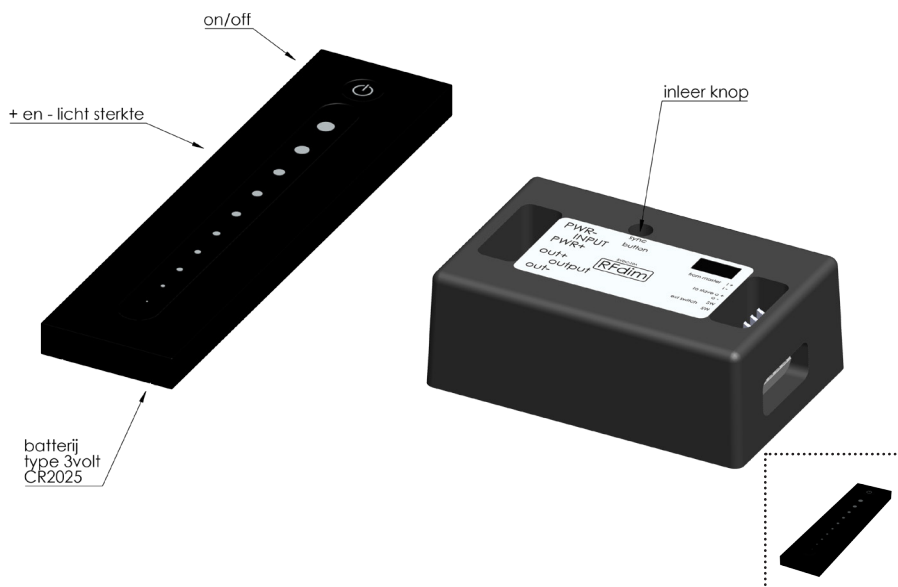

3 EN Optional dimming instruction

Dimming

If ordered with the optional dimmer, the dimmer is ready to use and programmed.

The fixture can be switched on and off with the remotecontrol.

The dimming is adjustable from 0% to 100%.

Synchronising remotecontrol and dimmodule

1. Switch off the power
2. Connect the dimmodule according to wiringdiagram.
3. Switch on power. Push the programmingbutton , push immediately on one of the buttons of the remotecontrol. The fixture blinks 2 times and is ready for use.

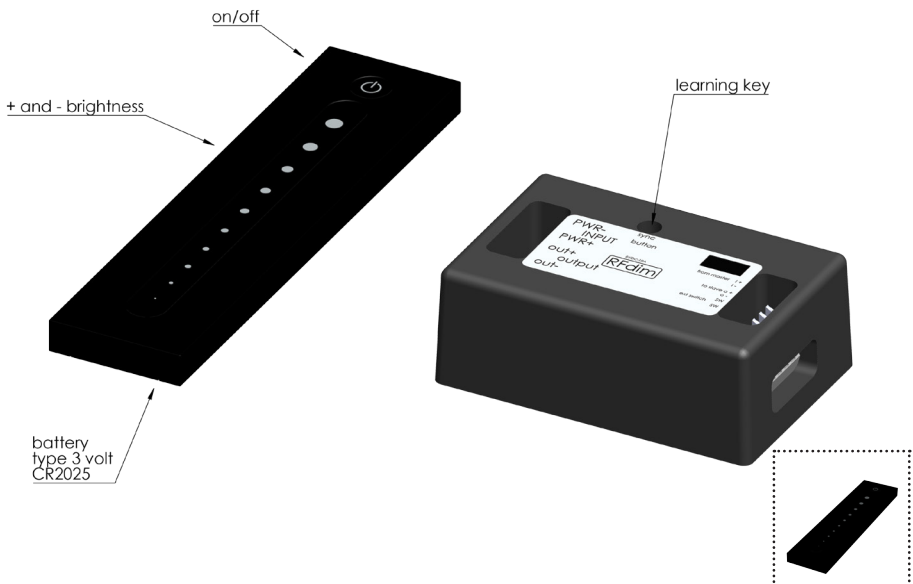

4 DE Optional anweisungen für dimmen

Dimmen

Falls mit Option Dimmer bestellt wird, ist der Dimmer fertig und programmiert.

Die Leuchte kann an- und ausgeschaltet werden mit den Fernbedienung.
Stufenlos dimmbar von 0% bis 100%.

Synchronisieren vom Fernbedienung und Dimmodul

1. Strom ausschalten
2. Dimmodul anschliessen laut verdrahtungsdiagram.
3. Strom anschalten. Programtaste eindrücken. Gleich einer Taste vom Fernbedienung drücken. Die Leuchte blinkt 2 Mal und is fertig.

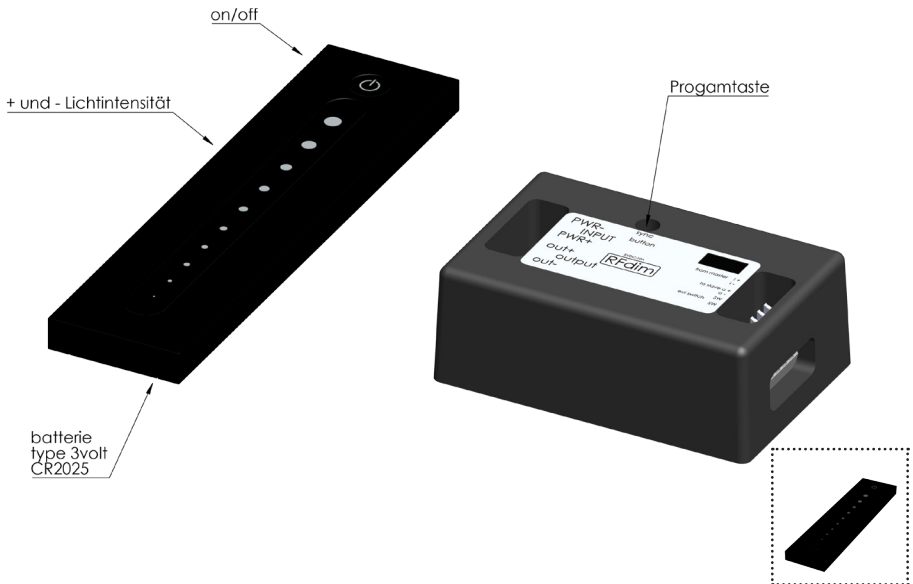

5.1 NL Installatie / EN Installation / DE Installation

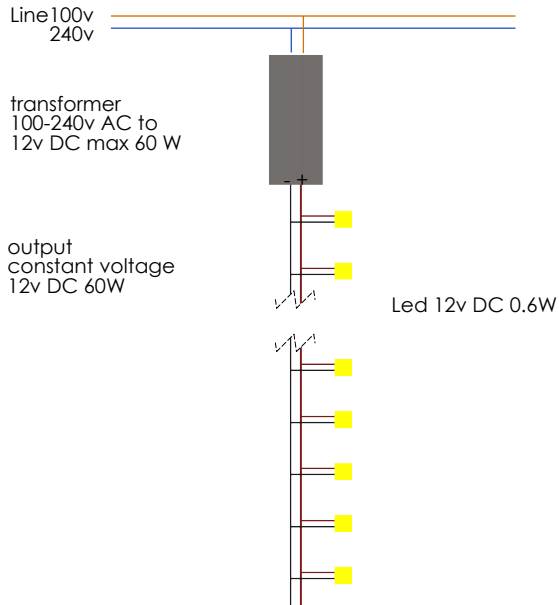

5.2

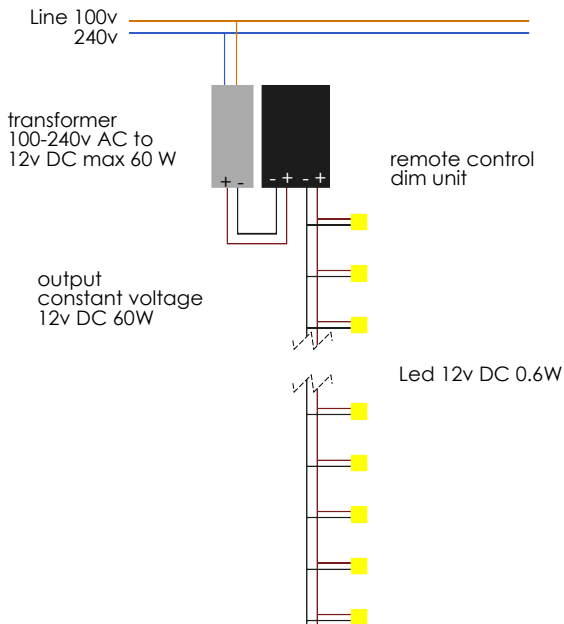

5.3 NL Installatie / EN Installation / DE Installation

Sirio 125 suspension

- 50x Circuitboard 12V/0,6W= 30 W
-x Downlight 12V/3W= W

Sirio Disc 70 suspension

- 50x Circuitboard 12V/0,6W= 30 W
-x Downlight 12V/3W= W

Sirio 180 suspension

- 70x Circuitboard 12V/0,6W= 42 W
-x Downlight 12V/3W= W

Sirio Disc 130 suspension

- 130x Circuitboard 12V/0,6W= 78 W
-x Downlight 12V/3W= W

Sirio 200 suspension

- 80x Circuitboard 12V/0,6W= 48 W
-x Downlight 12V/3W= W

Sirio Disc 200 suspension

- 200x Circuitboard 12V/0,6W= 120 W
-x Downlight 12V/3W= W

Sirio custom suspension

-x Circuitboard 12V/0,6W= W
 -x Downlight 12V/3W= W
-

Tess 125 suspension

- 32x Circuitboard 12V/0,6W= 19,2 W
-x Downlight 12V/3W= W

Tess 180 suspension

- 46x Circuitboard 12V/0,6W= 27,6 W
-x Downlight 12V/3W= W

Tess 200 suspension

- 51x Circuitboard 12V/0,6W= 30,6 W
-x Downlight 12V/3W= W

Tess custom suspension

-x Circuitboard 12V/0,6W= W
-x Downlight 12V/3W= W



5.4 NL Installatie / EN Installation / DE Installation

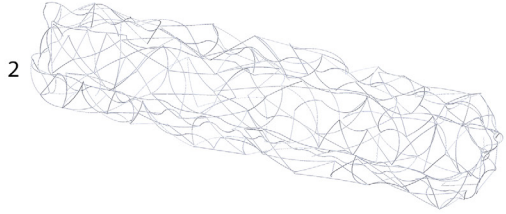
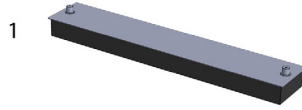
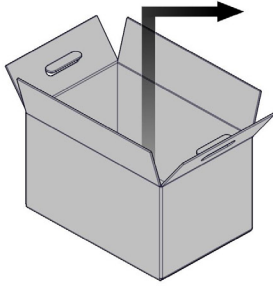

5.5

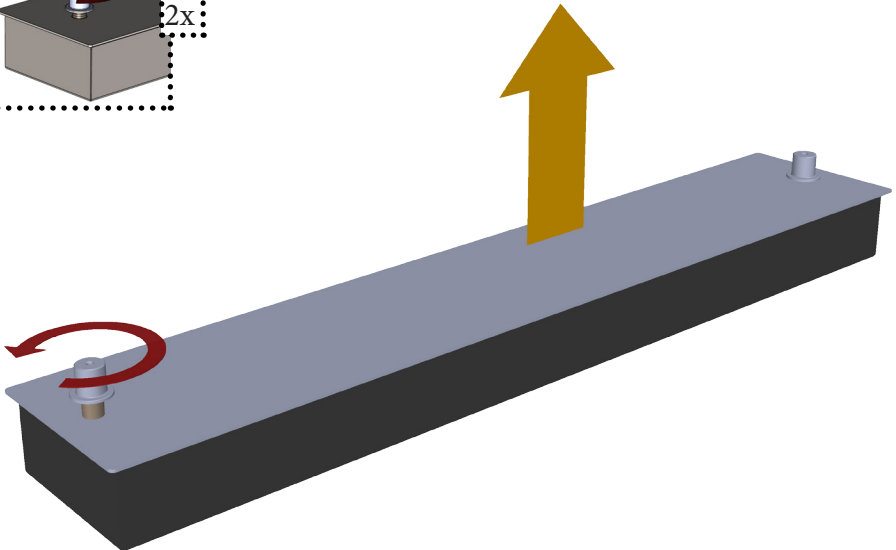
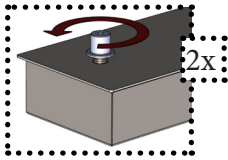

5.6 NL Installatie / EN Installation / DE Installation

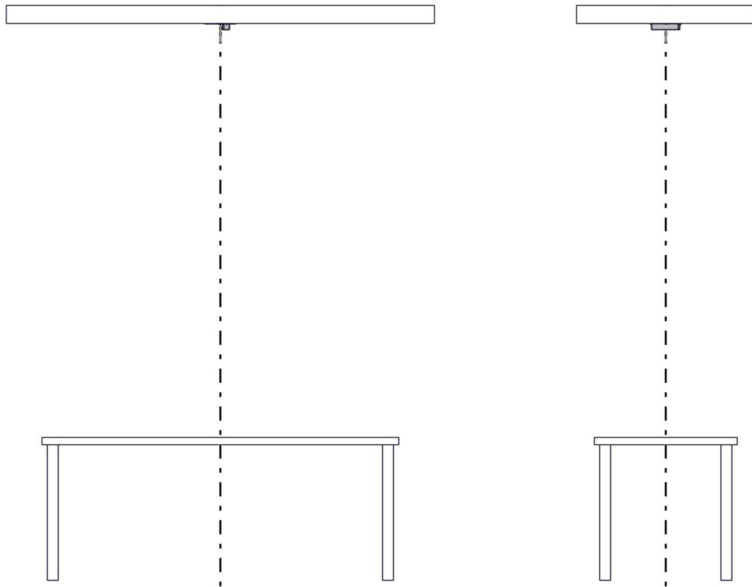

5.7

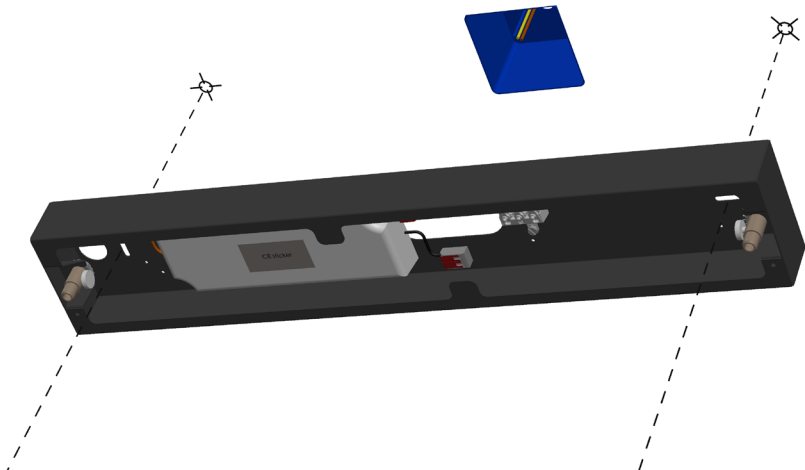
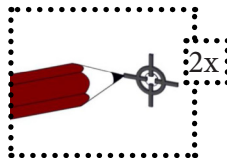
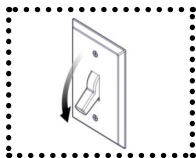



5.8 NL Installatie / EN Installation / DE Installation

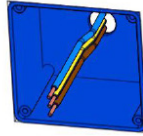
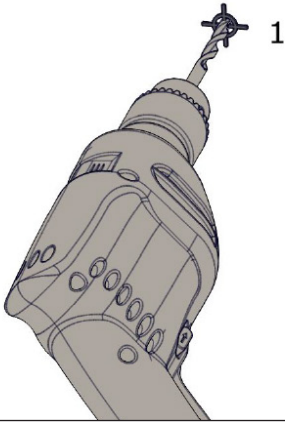
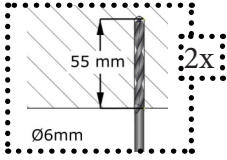

5.9

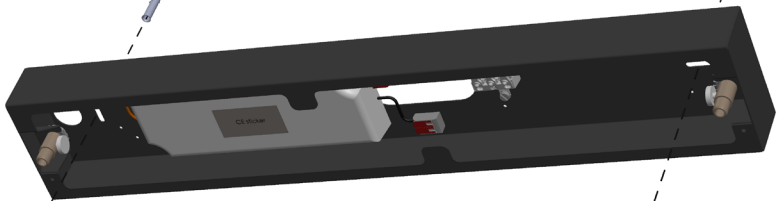
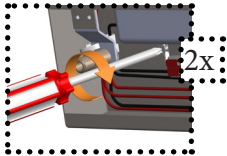

5.10 NL Installatie / EN Installation / DE Installation

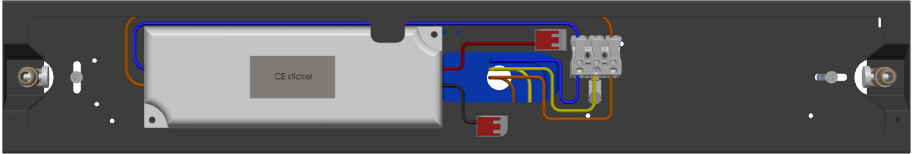
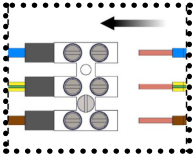

5.11

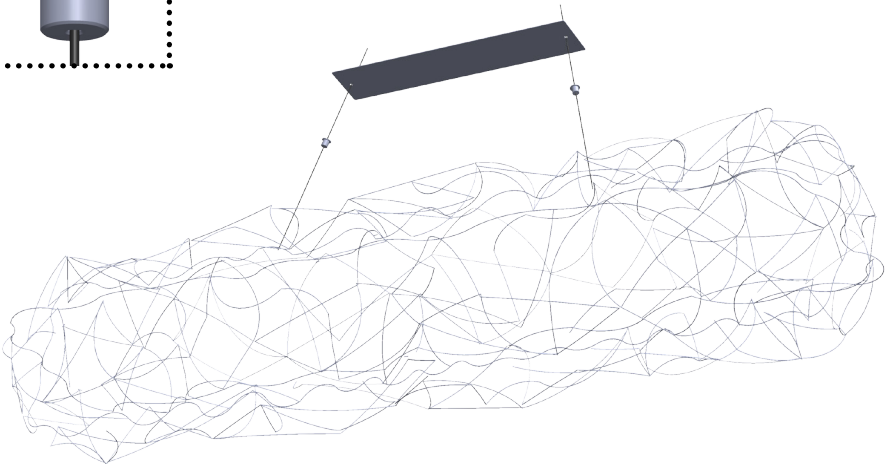
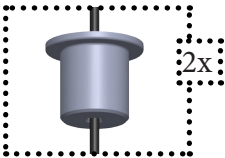

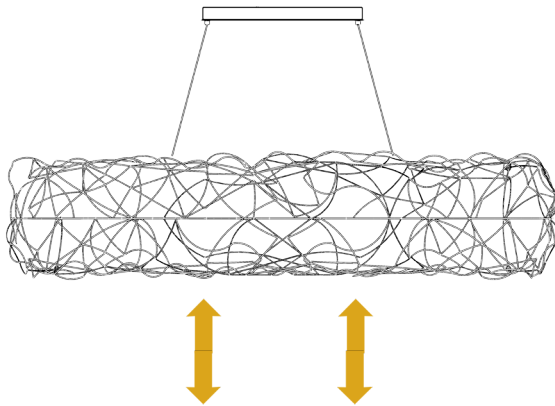
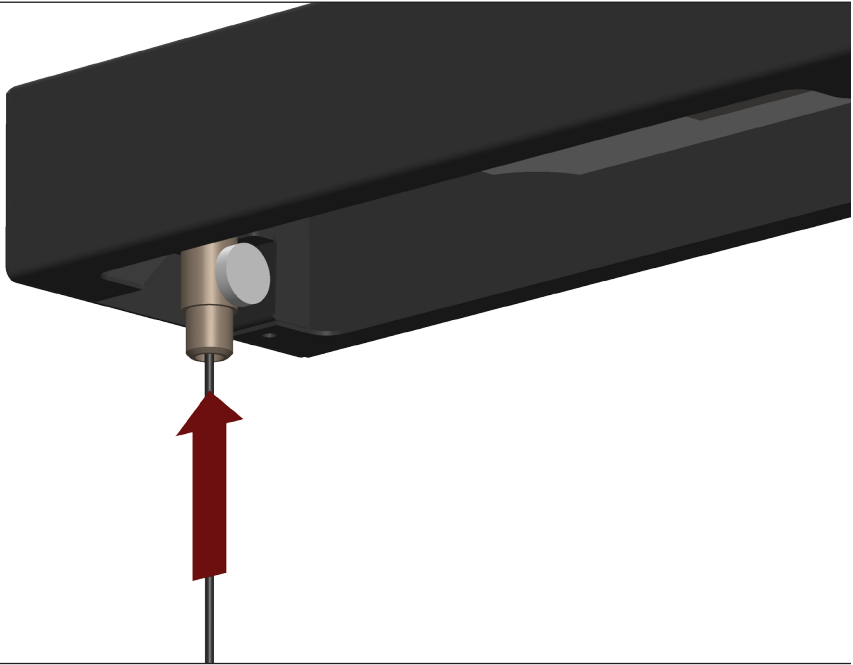

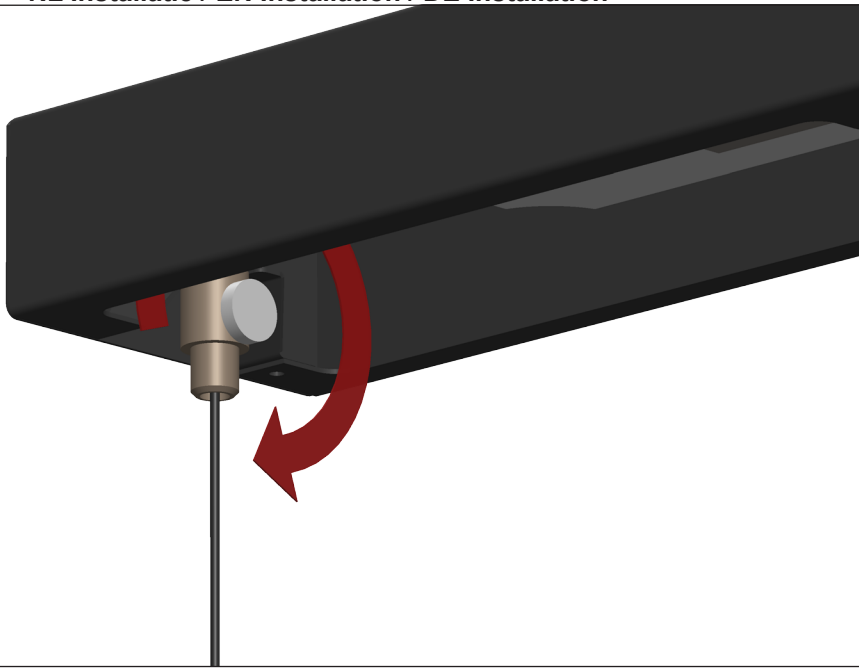

5.15

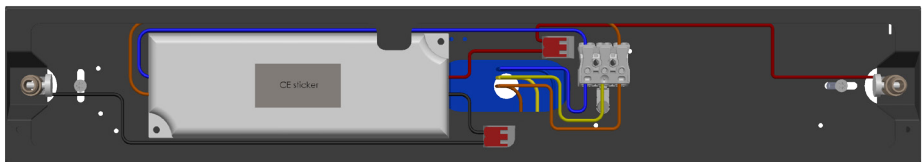
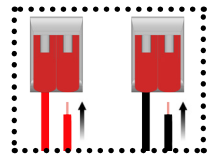
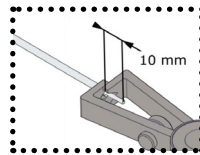
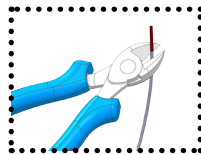
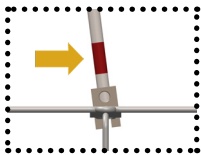

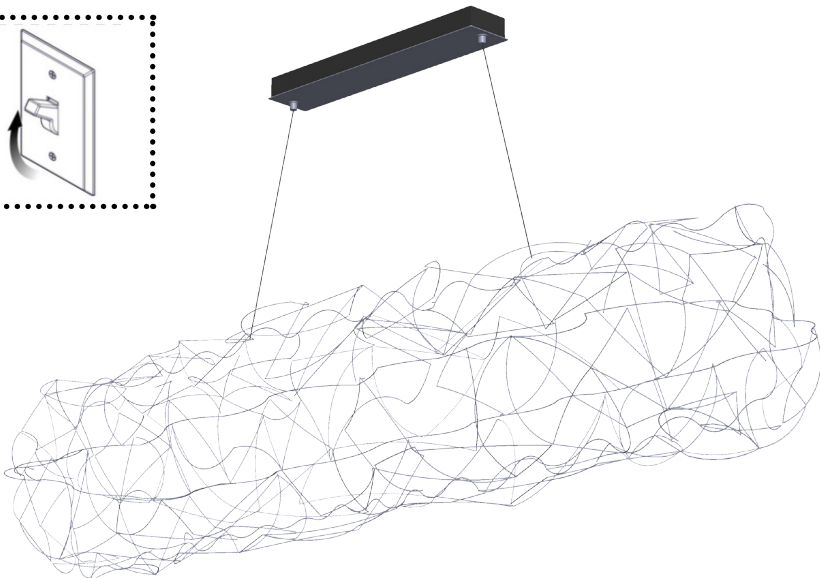
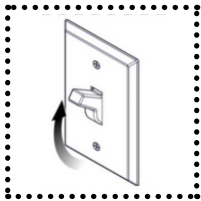
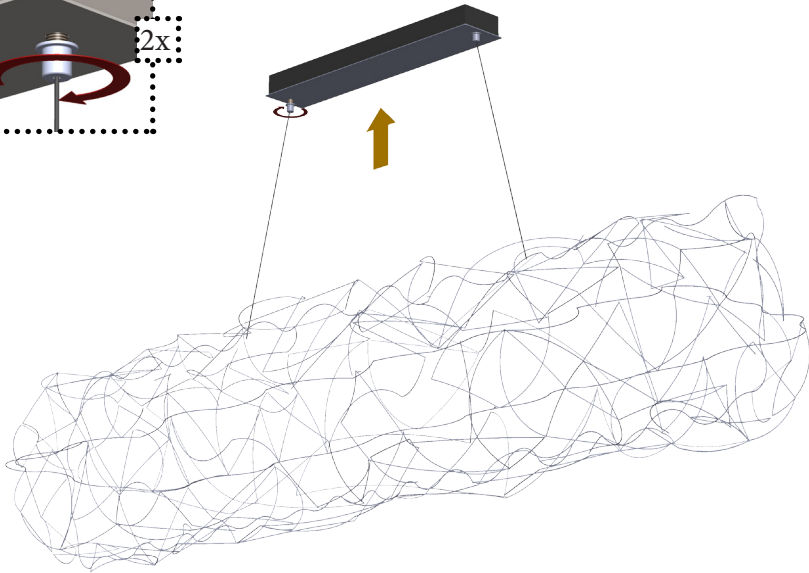
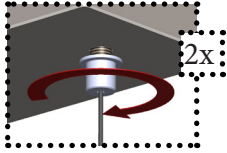



Quasar Holland B.V.
Burgstraat 2
4283 GG GIESSEN
THE NETHERLANDS

T. 31-183-447887
E. info@quasar.nl
I. www.quasar.nl

Date: 21-10-2020
Version: 1